



# 3K ColorVu Bullet & Turret Camera

## User Manual

### User Manual

Thank you for purchasing our product. If there are any questions, or requests, do not hesitate to contact the dealer.

This manual applies to the models below:

Type	Model
Type I Camera	DS-2CE12KF3T-E
	DS-2CE12KF3T
Type II Camera	DS-2CE10KF3T-E
	DS-2CE10KF3T
Type III Camera	DS-2CE72KF3T-E
	DS-2CE72KF3T

This manual may contain several technical mistakes or printing errors, and the content is subject to change without notice. The updates will be added to the new version of this manual. We will readily improve or update the products or procedures described in the manual.

02010020201210

## About this Manual

The Manual includes instructions for using and managing the Product. Pictures, charts, images and all other information hereinafter are for description and explanation only. The information contained in the Manual is subject to change, without notice, due to firmware updates or other reasons. Please find the latest version of this Manual at the Hikvision website (<https://www.hikvision.com/>).

Please use this Manual with the guidance and assistance of professionals trained in supporting the Product.

## Trademarks

**HIKVISION** and other Hikvision's trademarks and logos are the properties of Hikvision in various jurisdictions.

Other trademarks and logos mentioned are the properties of their respective owners.

## Disclaimer

TO THE MAXIMUM EXTENT PERMITTED BY APPLICABLE LAW, THIS MANUAL AND THE PRODUCT DESCRIBED, WITH ITS HARDWARE, SOFTWARE AND FIRMWARE, ARE PROVIDED "AS IS" AND "WITH ALL FAULTS AND ERRORS". HIKVISION MAKES NO WARRANTIES, EXPRESS OR IMPLIED, INCLUDING WITHOUT LIMITATION, MERCHANTABILITY, SATISFACTORY QUALITY, OR FITNESS FOR A PARTICULAR PURPOSE. THE USE OF THE PRODUCT BY YOU IS AT YOUR OWN RISK. IN NO EVENT WILL HIKVISION BE LIABLE TO YOU FOR ANY SPECIAL, CONSEQUENTIAL, INCIDENTAL, OR INDIRECT DAMAGES, INCLUDING, AMONG OTHERS, DAMAGES FOR LOSS OF BUSINESS PROFITS, BUSINESS INTERRUPTION, OR LOSS OF DATA, CORRUPTION OF SYSTEMS, OR LOSS OF DOCUMENTATION, WHETHER BASED ON BREACH OF CONTRACT, TORT (INCLUDING NEGLIGENCE), PRODUCT LIABILITY, OR OTHERWISE, IN CONNECTION WITH THE USE OF THE PRODUCT, EVEN IF HIKVISION HAS BEEN ADVISED OF THE POSSIBILITY OF SUCH DAMAGES OR LOSS.

YOU ACKNOWLEDGE THAT THE NATURE OF THE INTERNET PROVIDES FOR INHERENT SECURITY RISKS, AND HIKVISION SHALL NOT TAKE ANY RESPONSIBILITIES FOR ABNORMAL OPERATION, PRIVACY LEAKAGE OR OTHER DAMAGES RESULTING FROM CYBER-ATTACK, HACKER ATTACK, VIRUS INFECTION, OR OTHER INTERNET SECURITY RISKS; HOWEVER, HIKVISION WILL PROVIDE TIMELY TECHNICAL SUPPORT IF REQUIRED.

YOU AGREE TO USE THIS PRODUCT IN COMPLIANCE WITH ALL APPLICABLE LAWS, AND YOU ARE SOLELY RESPONSIBLE FOR ENSURING THAT YOUR USE CONFORMS TO THE APPLICABLE LAW. ESPECIALLY, YOU ARE RESPONSIBLE, FOR USING THIS PRODUCT IN A MANNER THAT DOES NOT INFRINGE ON THE RIGHTS OF THIRD PARTIES, INCLUDING WITHOUT LIMITATION, RIGHTS OF PUBLICITY, INTELLECTUAL PROPERTY RIGHTS, OR DATA PROTECTION AND OTHER PRIVACY RIGHTS. YOU SHALL NOT USE THIS PRODUCT FOR ANY PROHIBITED END-USES, INCLUDING THE DEVELOPMENT OR PRODUCTION OF WEAPONS OF MASS DESTRUCTION, THE DEVELOPMENT OR PRODUCTION OF CHEMICAL OR BIOLOGICAL WEAPONS, ANY ACTIVITIES IN THE CONTEXT RELATED TO ANY NUCLEAR EXPLOSIVE OR UNSAFE NUCLEAR FUEL-CYCLE, OR IN SUPPORT OF HUMAN RIGHTS ABUSES.

IN THE EVENT OF ANY CONFLICTS BETWEEN THIS MANUAL AND THE APPLICABLE LAW, THE LATER PREVAILS.

## Regulatory Information

### FCC Information

Please take attention that changes or modification not expressly approved by the party responsible for compliance could void the user's authority to operate the equipment.

**FCC compliance:** This equipment has been tested and found to comply with the limits for a Class A digital device, pursuant to part 15 of the FCC Rules. These limits are designed to provide reasonable protection against harmful interference when the equipment is operated in a commercial environment. This equipment generates, uses, and can radiate radio frequency energy and, if not installed and used in accordance with the instruction manual, may cause harmful interference to radio communications. Operation of this equipment in a residential area is likely to cause harmful interference in which case the user will be required to correct the interference at his own expense.

### FCC Conditions

This device complies with part 15 of the FCC Rules.

Operation is subject to the following two conditions:

1. This device may not cause harmful interference.
2. This device must accept any interference received, including interference that may cause undesired operation.

### EU Conformity Statement



This product and - if applicable - the supplied accessories too are marked with "CE" and comply therefore with the applicable harmonized European standards listed under the Low Voltage Directive 2014/35/EU, the EMC Directive 2014/30/EU, the RoHS Directive 2011/65/EU.



2012/19/EU (WEEE directive): Products marked with this symbol cannot be disposed of as unsorted municipal waste in the European Union. For proper recycling, return this product to your local supplier upon the purchase of equivalent new

equipment, or dispose of it at designated collection points. For more information see: [www.recyclethis.info](http://www.recyclethis.info).

2006/66/EC (battery directive): This product contains a



battery that cannot be disposed of as unsorted municipal waste in the European Union. See the product documentation for specific battery information. The battery is marked with this symbol, which may

include lettering to indicate cadmium (Cd), lead (Pb), or mercury (Hg). For proper recycling, return the battery to your supplier or to a designated collection point. For more information, see: [www.recyclethis.info](http://www.recyclethis.info).

### Industry Canada ICES-003 Compliance

This device meets the CAN ICES-3 (A)/NMB-3(A) standards requirements.

### Warning

This is a class A product. In a domestic environment this product may cause radio interference in which case the user may be required to take adequate measures.



## Safety Instruction

These instructions are intended to ensure that user can use the product correctly to avoid danger or property loss.

The precaution measure is divided into “Warnings” and “Cautions”.

**Warnings:** Serious injury or death may occur if any of the warnings are neglected.

**Cautions:** Injury or equipment damage may occur if any of the cautions are neglected.

	
<b>Warnings</b> Follow these safeguards to prevent serious injury or death.	<b>Cautions</b> Follow these precautions to prevent potential injury or material damage.



### Warnings

- In the use of the product, you must be in strict compliance with the electrical safety regulations of the nation and region.
- Input voltage should meet both the SELV (Safety Extra Low Voltage) and the Limited Power Source with 12 VDC according to the IEC60950-1 and IEC62368-1 standard. Refer to technical specifications for detailed information.
- The socket-outlet shall be installed near the equipment and shall be easily accessible.
- An all-pole mains switch shall be incorporated in the electrical installation of the building.
- Do not connect multiple devices to one power adapter to avoid over-heating or a fire hazard caused by overload.
- Make sure that the plug is firmly connected to the power socket.
- If smoke, odor or noise rise from the device, turn off the power at once and unplug the power cord, and then contact the service center.
- Never attempt to disassemble the camera by unprofessional personal.



### Cautions

- **CAUTION: Hot parts!** Burned fingers when handling the parts. Wait one-half hour after switching off before handling parts. This sticker is to indicate that the marked item can be hot and should not be touched without taking care. For device with this sticker, this device is intended for installation in a restricted access location, access can only be gained by service persons or by users who have been instructed about the reasons for the restrictions applied to the location and about any precautions that shall be taken.
- The equipment shall not be exposed to dripping or splashing and that no objects filled with liquids, such as vases, shall be placed on the equipment.
- **Shock hazard!** Disconnect all power sources before maintenance.



- No naked flame sources, such as lighted candles, should be placed on the equipment.
- Install the equipment according to the instructions in this manual.
- To prevent injury, this equipment must be securely attached to the floor/wall in accordance with the installation instructions.
- Do not drop the camera or subject it to physical shock.
- Do not touch sensor modules with fingers.
- Do not place the camera in extremely hot, cold (the operating temperature shall be  $-40^{\circ}\text{C}$  to  $60^{\circ}\text{C}$ ), dusty or damp locations, and do not expose it to high electromagnetic radiation.
- If cleaning is necessary, use clean cloth with a bit of ethanol and wipe it gently.
- Do not aim the camera at the sun or extra bright places.
- The sensor may be burned out by a laser beam, so when any laser equipment is in using, make sure that the surface of sensor will not be exposed to the laser beam.
- Do not expose the device to high electromagnetic radiation or extremely hot, cold, dusty or damp environment.
- To avoid heat accumulation, good ventilation is required for the operating environment.
- Keep the camera away from liquid while in use for non-water-proof device.
- While in delivery, the camera shall be packed in its original packing, or packing of the same texture.
- Use Hikvision DVR that supports the power over coaxial (PoC) technology if you power the device over coaxial cable.

# 1 Introduction

---

## 1.1 Product Features

The main features are as follows:

- High quality imaging with 3K resolution
- High performance CMOS sensor
- OSD menu with configurable parameters
- 24-hour color image
- Smart light
- 3-axis adjustment
- 3D Digital Noise Reduction

## 1.2 Overview

### 1.2.1 Overview of Type I Camera

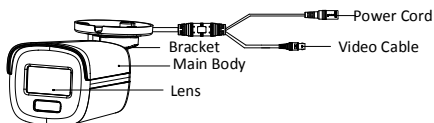

Figure 1-1 Overview of Type I Camera

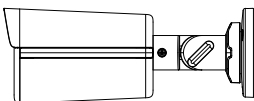

Figure 1-2 Side View of Type I Camera

### 1.2.2 Overview of Type II Camera

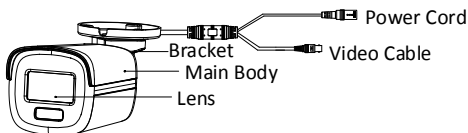

Figure 1-3 Overview of Type II Camera

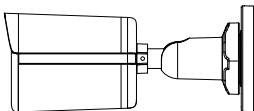

Figure 1-4 Side View of Type II Camera

### 1.2.3 Overview of Type III Camera

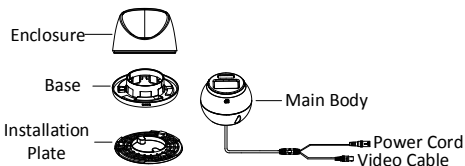

Figure 1-5 Overview of Type III Camera

# 2 Installation

---

## *Before you start*

- Make sure that the device in the package is in good condition and all the assembly parts are included.
- Make sure that all the related equipment is power-off during the installation.
- Check the specification of the products for the installation environment.
- Check whether the power supply is matched with your power output to avoid damage.
- Make sure the wall is strong enough to withstand three times the weight of the camera and the mount.
- If the product does not function properly, contact your dealer or the nearest service center. DO NOT disassemble the camera for repair or maintenance by yourself.

## 2.1 Installation of Type I and Type II Camera

### 2.1.1 Ceiling/Wall Mounting of Type I Camera Without Junction Box

#### **Before you start:**

Ceiling mounting and wall mounting are similar. Following steps take ceiling mounting as an example.

#### **Steps:**

1. Paste the drill template (supplied) to the place where you want to install the camera.
2. (Optional) For cement ceiling, drill the screw holes with a 5.5 mm drill and insert the supplied wall plugs.

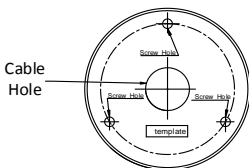

Figure 2-1 Drill Template

3. (Optional) Drill the cable hole, when the cables are routed through the ceiling.
4. Route and connect the power cord and video cable.
5. Align the screw holes in the bracket to the ceiling, and secure the camera with three PA4 × 25 screws (supplied).

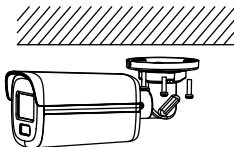

Figure 2-2 Secure Camera to Ceiling

6. Power on the camera to adjust the view angle according to the figure below.

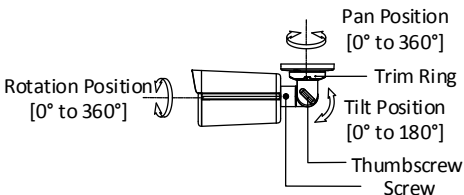

Figure 2-3 3-Axis Adjustment

- 1). Loosen the trim ring to adjust the pan position [0° to 360°].
  - 2). Loosen the thumbscrew to adjust the tilt position [0° to 180°].
  - 3). Loosen the screw to adjust the rotation position [0° to 360°].
7. Tighten the trim ring and screws to finish the installation.

### 2.1.2 Ceiling/Wall Mounting of Type II camera Without Junction Box

#### **Before you start:**

Ceiling mounting and wall mounting are similar. Following steps take ceiling mounting as an example.

#### **Steps:**

1. Paste the drill template (supplied) to the place where you want to install the camera.
2. (Optional) For cement ceiling, drill the screw holes with a 5.5 mm drill and insert the supplied wall plugs.

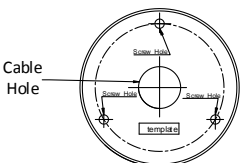

Figure 2-4 Drill Template

3. (Optional) Drill the cable hole, when the cables are routed through the ceiling.
4. Route and connect the power cord and video cable.
5. Align the screw holes in the bracket to the ceiling, and secure the camera with three PA4 × 25 screws (supplied).

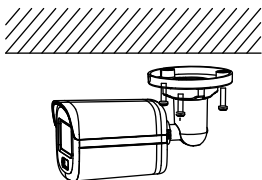

Figure 2-5 Secure Camera to Ceiling

6. Power on the camera to check whether the image on the monitor is gotten from the optimum angle. If not, turn the trim ring counterclockwise to loosen it and adjust the positions according to the figure below.

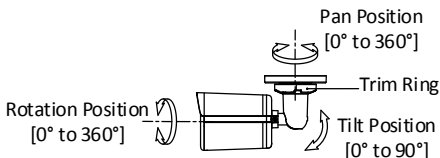

Figure 2-6 3-Axis Adjustment

7. Turn the trim ring clockwise to lock the positions.

### 2.1.3 Ceiling/Wall Mounting with Junction Box

#### **Before you start:**



- You need to purchase a junction box in advance.
  - Ceiling mounting and wall mounting are similar.
- Following steps take wall mounting as an example.

**Steps:**

1. Paste the drill template for junction box to the place where you want to install the camera.
2. (Optional) For cement wall, drill the screw holes with a 5.5 mm drill and insert the supplied wall plugs.

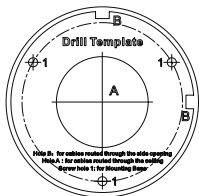

Figure 2-7 Drill Template for Junction Box

3. (Optional) Drill the cable hole, when the cables are routed through the wall.
4. Take apart the junction box.
5. Align the screw holes of the camera with those on the junction box cover. Attach the camera to the junction box cover with three PM4 × 10 screws.

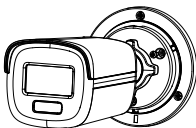

Figure 2-8 Attach Camera to Junction Box Cover

6. Secure the junction box body on the wall with three PA4 × 25 screws (supplied).

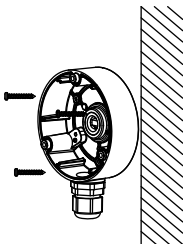

Figure 2-9 Secure Junction Box on Wall

7. Route the cables through the bottom cable hole or side cable hole of the junction box and connect the cables.
8. Fix the junction box cover on its body with three PM3 × 16 L6 screws that come with the junction box.

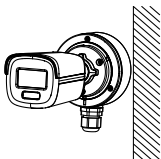

Figure 2-10 Fix Junction Box Cover on Its Body

- Refer to steps 6 to 7 of 2.1.2 or 2.1.2 Ceiling/Wall Mounting of Type II camera Without Junction Box to adjust the view angle.

## 2.2 Installation of Type III Camera

### 2.2.1 Ceiling Mounting without Junction Box

#### Steps:

- Paste the drill template (supplied) to the place where you want to install the camera.
- (Optional) For cement ceiling, drill the screw holes with a 5.5 mm drill and insert the supplied wall plugs.

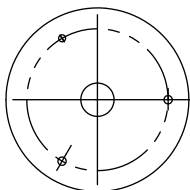

Figure 2-11 Drill Template

- Attach the installation plate to the ceiling and secure it with three PA4 × 25 screws (supplied).

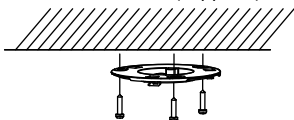

Figure 2-12 Attach Installation Plate to Ceiling

- Fit the camera onto the installation plate.

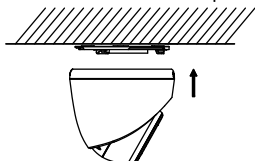

Figure 2-13 Fit Camera

- Turn the camera clockwise until it snaps into the installation plate.

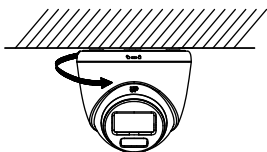

Figure 2-14 Snap Camera into Installation Plate

- Connect the power cord and video cable.
- Power on the camera to check whether the image on the monitor is gotten from the optimum angle. If not, adjust the camera according to the figure below.

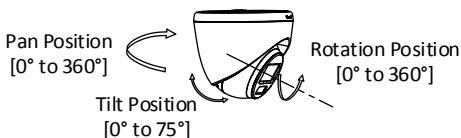

Figure 2-15 3-Axis Adjustment

- 1). Rotate the enclosure to adjust the pan position [0° to 360°].
- 2). Move the main body up and down to adjust the tilt position [0° to 75°].
- 3). Rotate the main body to adjust the rotation position [0° to 360°].

## 2.2.2 Ceiling Mounting with Junction Box/Inclined Ceiling Mount

### **Before you start:**

- You need to purchase a junction box or inclined ceiling mount in advance.
- Ceiling mounting with junction box and inclined ceiling mount are similar. Following steps take junction box as an example.

### **Steps:**

1. Paste the drill template for junction box to the place where you want to install the camera.
2. (Optional) For cement ceiling, drill the screw holes with a 5.5 mm drill and insert the supplied wall plugs.



Figure 2-16 Drill Template

3. (Optional) Drill the cable hole, when the cables are routed through the wall.
4. Take apart the junction box.
5. Install the installation plate to the junction box cover with three PM4 screws.

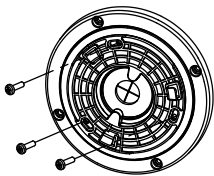

Figure 2-17 Install Installation Plate to Junction Box Cover

6. Fit the camera onto the installation plate.

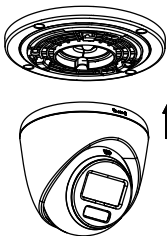

Figure 2-18 Fit Camera

7. Turn the camera clockwise until it snaps into the installation plate.



Figure 2-19 Snap Camera into Installation Plate

8. Secure the junction box body on the ceiling with four PA4 × 25 screws.

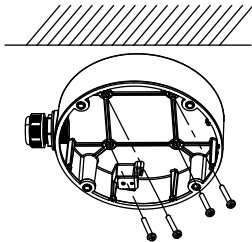

Figure 2-20 Secure Junction Box Body

9. Route the cables through the bottom cable hole or the side cable hole of the junction box and connect the cables.
10. Combine the junction box cover with its body with four PM4 screws.

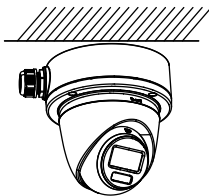

Figure 2-21 Combine Junction Box Cover with Body

11. Refer to step 7 of 2.2.1 *Ceiling Mounting without Junction Box* to adjust the angle.

### 2.2.3 Wall Mounting

#### **Before you start:**

You need to purchase a wall mount in advance.

#### **Steps:**

1. Drill  $\Phi$  10 mm screw holes in the wall where you want to install the wall mount.
2. Use four M6 expansion bolts to fix the wall mount onto the wall.

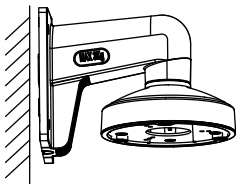

Figure 2-22 Fix Wall Mount

3. Use three PM4 × 10 screws to fix the installation plate onto the wall mount.

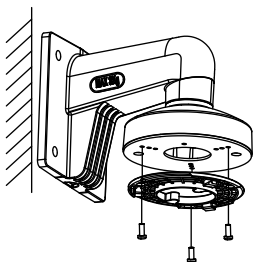

Figure 2-23 Fix Installation Plate

- Repeat the step 4 to 7 of 2.2.1 *Ceiling Mounting without Junction Box* to finish the installation.



Figure 2-24 Finish Installation

### 3 Menu Description

Please follow the steps below to call the menu.

**Note:**

The actual display may vary with your camera model.

**Steps:**

- Connect the camera with the TVI DVR and the monitor, as shown in figure 3-1.



Figure 3-1 Connection

- Power on the camera, TVI DVR, and monitor to view the image on the monitor.
- Click PTZ Control to enter the PTZ Control interface.
- Call the camera menu by clicking  button, clicking Iris+, or calling preset No. 95.

**Note:**

Functions may differ from models. Please take the actual product as standard.

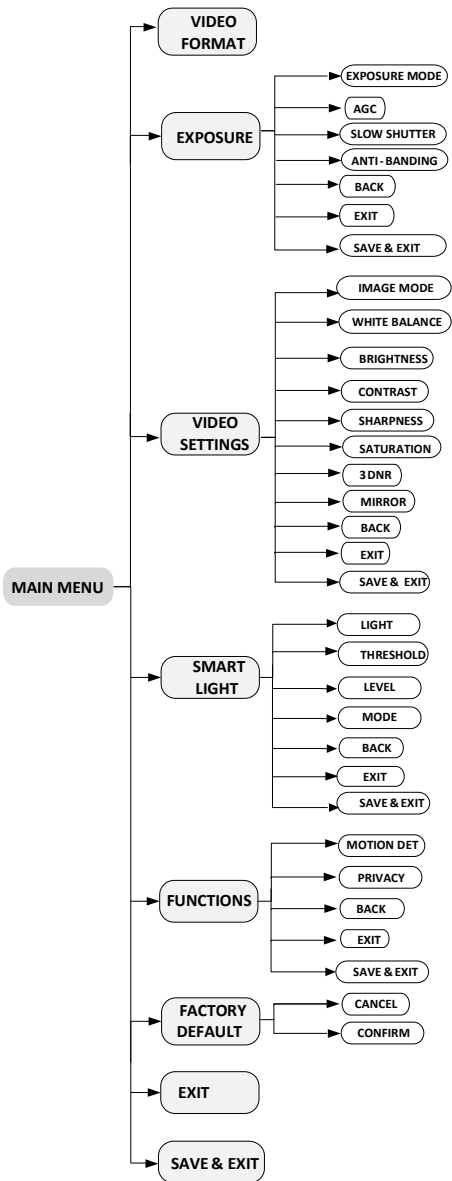

Figure 3-2 Main Menu Overview

5. Click the direction buttons to control the camera.
  - 1). Click up/down direction buttons to select menu options.
  - 2). Click Iris + to confirm the selection.
  - 3). Click left/right direction buttons to adjust the value of the selected option.

### 3.1 VIDEO FORMAT

You can set the video format to 3K@20fps, 4MP@25fps, 4MP@30fps, 2MP@25fps, or 2MP@30fps.

## 3.2 EXPOSURE

### EXPOSURE MODE

You can set the **EXPOSURE MODE** to **GLOBAL**, **BLC**, **HLC**, **WDR**, or **HLS**.

- **GLOBAL**

**GLOBAL** refers to the normal exposure mode that adjusts lighting distribution, variations, and non-standard processing.

- **BLC (Backlight Compensation)**

**BLC (Backlight Compensation)** compensates light to the object in the front to make it clear, but this may cause over-exposure of the background where the light is strong.

- **HLC (Highlight Compensation)**

**HLC** stands for highlight compensation. The camera detects strong spots (over-exposure portion of image) and reduces the brightness of strong spots to improve the overall images.

- **WDR (Wide Dynamic Range)**

The wide dynamic range (**WDR**) function helps the camera provide clear images even under back light circumstances. When there are both very bright and very dark areas simultaneously in the field of view, **WDR** balances the brightness level of the whole image and provides clear detailed images.

- **HLS (Highlight Suppression)**

It is the same visual effect as the solar eclipse. If the brightness of a part in the image exceeds the threshold, this part will become black. Then whole image can be clear.

### **AGC (Auto Gain Control)**

It optimizes the clarity of the image in poor light conditions. The **AGC** level can be set to **HIGH**, **MEDIUM**, or **LOW**.

**Note:**

The noise will be amplified when setting the **AGC** level.

### **SLOW SHUTTER**

**SLOW SHUTTER** increases the exposure time on a single frame, which makes a camera more sensitive to the light so it can produce images even in low lux conditions.

**Note:**

The function is not supported by the device model with power over coaxial (PoC) technology.

### **ANTI-BANDING**

**ANTI-BANDING** is a camera setting that prevents the appearance of horizontal lines (banding) when photographing images in low frequency light and high brightness environments.

## 3.3 VIDEO SETTINGS

Move the cursor to **VIDEO SETTINGS** and click Iris+ to enter the submenu. **IMAGE MODE**, **WHITE BALANCE**, **BRIGHTNESS**, **CONTRAST**, **SHARPNESS**, **SATURATION**, **3DNR**, and **MIRROR** are adjustable.

VIDEO SETTINGS	
IMAGE MODE	◀ STD ▶
WHITE BALANCE	↵
BRIGHTNESS	◀ 5 ▶
CONTRAST	◀ 5 ▶
SHARPNESS	◀ 5 ▶
SATURATION	◀ 5 ▶
3DNR	◀ 5 ▶
MIRROR	◀ OFF ▶
BACK	↵
EXIT	↵
SAVE & EXIT	↵

Figure 3-3 VIDEO SETTINGS

## IMAGE MODE

**IMAGE MODE** is used to adjust the image saturation, and you can set it to **STD** (Standard), **HIGH-SAT** (High Saturation), or **HIGHLIGHT** (better indoor facial details).

## WHITE BALANCE

White balance, the white rendition function of the camera, is to adjust the color temperature according to the environment. It can remove unrealistic color casts in the image. You can set **WHITE BALANCE** mode to **AUTO**, **OUTDOOR**, **GLOBAL**, or **MANUAL**.

- **AUTO**

The white balance can automatically adjust according to the environment.

- **OUTDOOR**

You can choose this mode for outdoor environment.

- **GLOBAL**

You can choose this mode in complicated scene, such as public square.

**Note:**

**AWB LOCK** is supported under **AUTO**, **OUTDOOR**, and **GLOBAL** modes.

- **MANUAL**

You can set the **R-GAIN/B-GAIN** value to adjust the shades of red/blue color of the image.

WHITE BALANCE	
MODE	◀ MANUAL ▶
R-GAIN	◀ 5 ▶
B-GAIN	◀ 5 ▶
BACK	↵
EXIT	↵
SAVE&EXIT	↵

Figure 3-4 WHITE BALANCE

## BRIGHTNESS

Brightness refers to the brightness of the image. You can set the brightness value from 1 to 9 to darken or brighten the image. The greater the value is, the brighter the image is.

## CONTRAST

This feature enhances the difference in color and light between parts of an image.

## SHARPNESS

Sharpness determines the amount of detail an imaging system can reproduce.



## SATURATION

Saturation is the proportion of pure chromatic color in the total color sensation. Adjust this feature to change the saturation of the color.

## 3DNR (3D DNR)

3DNR refers to 3D digital noise reduction. Comparing with the general 2D digital noise reduction, the 3D digital noise reduction function processes the noise between two frames besides processing the noise in one frame. The noise will be much less and the video will be clearer.

## MIRROR

**OFF**, **H**, **V**, and **HV** are selectable for mirror.

**OFF**: The mirror function is disabled.

**H**: The image flips 180° horizontally.

**V**: The image flips 180° vertically.

**HV**: The image flips 180° both horizontally and vertically.

## 3.4 SMART LIGHT

Under the **SMART LIGHT** sub-menu, you can set the mode to **OFF** or **AUTO**.

- **OFF**

Set it to **OFF** to give up this function.

- **AUTO**

You can set **THRESHOLD** and **LEVEL** in this section.

SMART LIGHT	
LIGHT	◀ AUTO ▶
THRESHOLD	◀ 2 ▶
LEVEL	◀ 5 ▶
MODE	◀ MODE 1 ▶
BACK	↵
EXIT	↵
SAVE & EXIT	↵

Figure 3-5 SMART LIGHT

## THRESHOLD

The higher the threshold is, the more sensitive the device is to dark environment.

## LEVEL

You can adjust the maximum brightness of supplement light.

## MODE

The function is to reduce frame rate in low-light environment in order to increase SNR and enhance the brightness of the image.

- **MODE1**: Turn on the function.

- **MODE2**: Turn off the function.

## 3.5 FUNCTIONS

### 3.5.1 MOTION DET

**MOTION DET** refers to motion detection. With motion detection feature, motion can be detected in any part of a camera's view. You can configure full screen or a number of zones in a camera's view where motion is to be detected.

### **3.5.2 PRIVACY**

This function allows you to block or mask certain area of a scene to protect personal privacy from being recorded or live viewed. You can turn on/off the **PRIVACY** to meet your needs.

### **3.6 FACTORY DEFAULT**

Reset all the settings, except for image mode, to factory defaults.

### **3.7 EXIT**

Move the cursor to **EXIT** and click Iris+ to exit the menu.

### **3.8 SAVE & EXIT**

Move the cursor to **SAVE & EXIT** and click Iris+ to save the settings and exit the menu.

**UD22233B**