

**HIKVISION**



# **Video Intercom Vandal-Resistant Door Station**

Quick Start Guide

UD03855B-B

**Quick Start Guide**

©2017 Hangzhou Hikvision Digital Technology Co., Ltd.

This quick start guide is intended for users of the models below:

Series	Model
Vandal-Resistant Door Station	DS-KB8112-IM

It includes instructions on how to use the Product. The software embodied in the Product is governed by the user license agreement covering that Product.

**About this Manual**

This Manual is subject to domestic and international copyright protection. Hangzhou Hikvision Digital Technology Co., Ltd. (“Hikvision”) reserves all rights to this manual. This manual cannot be reproduced, changed, translated, or distributed, partially or wholly, by any means, without the prior written permission of Hikvision.

**Trademarks**

**HIKVISION** and other Hikvision marks are the property of Hikvision and are registered trademarks or the subject of applications for the same by Hikvision and/or its affiliates. Other trademarks mentioned in this manual are the properties of their respective owners. No right of license is given to use such trademarks without express permission.

**Disclaimer**

TO THE MAXIMUM EXTENT PERMITTED BY APPLICABLE LAW, HIKVISION MAKES NO WARRANTIES, EXPRESS OR IMPLIED, INCLUDING WITHOUT LIMITATION THE IMPLIED WARRANTIES OF

MERCHANTABILITY AND FITNESS FOR A PARTICULAR PURPOSE, REGARDING THIS MANUAL. HIKVISION DOES NOT WARRANT, GUARANTEE, OR MAKE ANY REPRESENTATIONS REGARDING THE USE OF THE MANUAL, OR THE CORRECTNESS, ACCURACY, OR RELIABILITY OF INFORMATION CONTAINED HEREIN. YOUR USE OF THIS MANUAL AND ANY RELIANCE ON THIS MANUAL SHALL BE WHOLLY AT YOUR OWN RISK AND RESPONSIBILITY.

TO THE MAXIMUM EXTENT PERMITTED BY APPLICABLE LAW, IN NO EVENT WILL HIKVISION, ITS DIRECTORS, OFFICERS, EMPLOYEES, OR AGENTS BE LIABLE TO YOU FOR ANY SPECIAL, CONSEQUENTIAL, INCIDENTAL, OR INDIRECT DAMAGES, INCLUDING, AMONG OTHERS, DAMAGES FOR LOSS OF BUSINESS PROFITS, BUSINESS INTERRUPTION, SECURITY BREACHES, OR LOSS OF DATA OR DOCUMENTATION, IN CONNECTION WITH THE USE OF OR RELIANCE ON THIS MANUAL, EVEN IF HIKVISION HAS BEEN ADVISED OF THE POSSIBILITY OF SUCH DAMAGES.

SOME JURISDICTIONS DO NOT ALLOW THE EXCLUSION OR LIMITATION OF LIABILITY OR CERTAIN DAMAGES, SO SOME OR ALL OF THE ABOVE EXCLUSIONS OR LIMITATIONS MAY NOT APPLY TO YOU.

### **Support**

Should you have any questions, please do not hesitate to contact your local dealer.

## Regulatory Information

### FCC Information

Please take attention that changes or modification not expressly approved by the party responsible for compliance could void the user's authority to operate the equipment.

**FCC compliance:** This equipment has been tested and found to comply with the limits for a Class B digital device, pursuant to part 15 of the FCC Rules. These limits are designed to provide reasonable protection against harmful interference in a residential installation. This equipment generates, uses and can radiate radio frequency energy and, if not installed and used in accordance with the instructions, may cause harmful interference to radio communications. However, there is no guarantee that interference will not occur in a particular installation. If this equipment does cause harmful interference to radio or television reception, which can be determined by turning the equipment off and on, the user is encouraged to try to correct the interference by one or more of the following measures:

- Reorient or relocate the receiving antenna.
- Increase the separation between the equipment and receiver.
- Connect the equipment into an outlet on a circuit different from that to which the receiver is connected.
- Consult the dealer or an experienced radio/TV technician for help.

### FCC Conditions

This device complies with part 15 of the FCC Rules. Operation is subject to the following two conditions:

1. This device may not cause harmful interference.
2. This device must accept any interference received, including interference that may cause undesired operation.

### **EU Conformity Statement**



This product and - if applicable - the supplied accessories too are marked with "CE" and comply therefore with the applicable harmonized European standards listed under the EMC Directive 2014/30/EU, the RoHS Directive 2011/65/EU.



2012/19/EU (WEEE directive): Products marked with this symbol cannot be disposed of as unsorted municipal waste in the European Union. For proper recycling, return this product to your local supplier upon the purchase of equivalent new equipment, or dispose of it at designated collection points. For more information see:

[www.recyclethis.info](http://www.recyclethis.info)



2006/66/EC (battery directive): This product contains a battery that cannot be disposed of as unsorted municipal waste in the European Union. See the product documentation for specific battery information. The battery is marked with this symbol, which may include lettering to indicate cadmium (Cd), lead (Pb), or mercury (Hg). For proper recycling, return the battery to your supplier or to a designated collection point. For more information see:

[www.recyclethis.info](http://www.recyclethis.info)

### **Industry Canada ICES-003 Compliance**

This device meets the CAN ICES-3 (B)/NMB-3(B) standards requirements.



## Safety Instruction

These instructions are intended to ensure that user can use the product correctly to avoid danger or property loss.

The precaution measure is divided into **Warnings** and **Cautions**:

**Warnings:** Neglecting any of the warnings may cause serious injury or death.

**Cautions:** Neglecting any of the cautions may cause injury or equipment damage.

	
<b>Warnings</b> Follow these safeguards to prevent serious injury or death.	<b>Cautions</b> Follow these precautions to prevent potential injury or material damage.



### Warnings

- All the electronic operation should be strictly compliance with the electrical safety regulations, fire prevention regulations and other related regulations in your local region.
- Please use the power adapter, which is provided by normal company. The power consumption cannot be less than the required value.
- Do not connect several devices to one power adapter as adapter overload may cause over-heat or fire hazard.

- Please make sure that the power has been disconnected before you wire, install or dismantle the device.
- When the product is installed on wall or ceiling, the device shall be firmly fixed.
- If smoke, odors or noise rise from the device, turn off the power at once and unplug the power cable, and then please contact the service center.
- If the product does not work properly, please contact your dealer or the nearest service center. Never attempt to disassemble the device yourself. (We shall not assume any responsibility for problems caused by unauthorized repair or maintenance.)



### **Cautions**

- Do not drop the device or subject it to physical shock, and do not expose it to high electromagnetism radiation. Avoid the equipment installation on vibrations surface or places subject to shock (ignorance can cause equipment damage).
- Do not place the device in extremely hot (refer to the specification of the device for the detailed operating temperature), cold, dusty or damp locations, and do not expose it to high electromagnetic radiation.
- The device cover for indoor use shall be kept from rain and moisture.
- Exposing the equipment to direct sun light, low ventilation or heat source such as heater or radiator is forbidden (ignorance can cause fire danger).



- Do not aim the device at the sun or extra bright places. A blooming or smear may occur otherwise (which is not a malfunction however), and affecting the endurance of sensor at the same time.
- Please use the provided glove when open up the device cover, avoid direct contact with the device cover, because the acidic sweat of the fingers may erode the surface coating of the device cover.
- Please use a soft and dry cloth when clean inside and outside surfaces of the device cover, do not use alkaline detergents.
- Please keep all wrappers after unpack them for future use. In case of any failure occurred, you need to return the device to the factory with the original wrapper. Transportation without the original wrapper may result in damage on the device and lead to additional costs.
- Improper use or replacement of the battery may result in hazard of explosion. Replace with the same or equivalent type only. Dispose of used batteries according to the instructions provided by the battery manufacturer.

## Table of Contents

<b>1 Introduction</b> .....	<b>1</b>
1.1 Overview .....	1
1.2 Features .....	1
<b>2 Appearance</b> .....	<b>3</b>
<b>3 Terminals and Wiring</b> .....	<b>4</b>
3.1 Terminals and Interfaces .....	4
3.2 Wiring Description .....	5
3.2.1 Door Lock Wiring .....	5
3.2.2 Door Magnetic Wiring .....	6
3.2.3 Exit Button Wiring .....	6
3.2.4 Alarm Device Input Wiring .....	7
<b>4 Installation</b> .....	<b>8</b>
4.1.1 Wall Mounting Plate .....	8
4.1.2 Wall Mounting .....	9
<b>5 Remote Operation</b> .....	<b>12</b>
5.1 Activating Device .....	12
5.1.1 Activation via Web Browser .....	12
5.1.2 Activation via Batch Configuration Tool .....	13
5.2 Editing Network Parameters .....	15
5.3 Adding Device .....	16
5.3.1 Adding Online Device .....	16
5.3.2 Adding Device by IP Address .....	18
5.4 Accessing via Web Browser .....	19
<b>6 Local Operation</b> .....	<b>21</b>
<b>7 Appendix</b> .....	<b>23</b>
Installation Notice .....	23
Wiring Cables .....	23

# 1 Introduction

---

## 1.1 Overview

The DS-KB8112-IM is a vandal-resistant door station, which has passed IK 9 (Impact Protection Level). The door station, featuring in the vandal-resistant design, convenient installation, and easy operation, supports the video intercom function, access control function, door magnetic alarm, motion detection, and so on. As an intelligent device, the vandal-proof door station is mainly applied in the villa for improving the living security.

## 1.2 Features

### Basic Functions

- Video intercom function, supporting the communication with the master station, and the indoor station
- Access control function, supporting multiple door opening modes (the indoor station, the master station, the client software, and the web)
- Self-adaptive IR supplement with max. 5-meter IR distance
- High-performance embedded SOC processor
- IK 9 and IP 66

### Video/Audio Functions

- HD video surveillance with WDR wide angle and high performance CMOS, up to 720P @ 30 fps

- Noise suppression and echo cancellation
- H.264 video compression standard
- Low illumination

### Alarm Functions

- Supports the door magnetic alarm
- Auto-uploads alarm messages to the master station or the client software

### Remote Controls

- Remote reboot, remote upgrade, time synchronization via NTP, and batch configuration function
- Supports Web remote access and OSD display
- Supports motion detection

### Additional Features

- ISAPI (Internet Server Application Programming Interface) and ONVIF (Open Network Video Interface Forum) supported, to ensure greater compatibility and interoperability among different platforms
- Supports bit rate and frame rate configuration, P/N video standard configuration, Email configuration, and auto day & night switch
- Auto-uploads captured pictures to the FTP or the client software while unlocking the door

## 2 Appearance

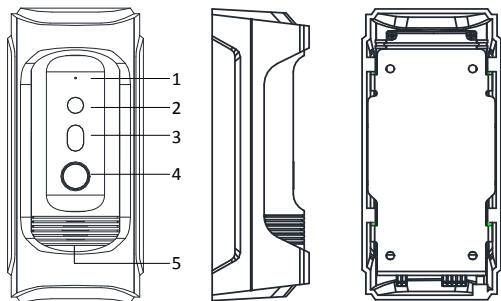

Figure 2-1 Door Station Overview

Table 2-1 Components Description

No.	Description
1	Microphone
2	Built-in Camera
3	Low Illumination Supplement Light
4	Call Button
5	Loudspeaker

## 3 Terminals and Wiring

### 3.1 Terminals and Interfaces

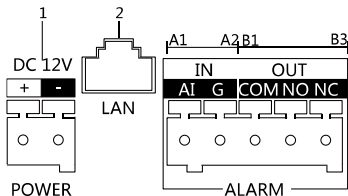

Figure 3-1 Terminals and Interfaces

Table 3-1 Descriptions of Terminals and Interfaces

Name	No.	Interface	Description
Power Supply	1	12 VDC	12 VDC Power Supply Input
LAN	2	LAN	Network Interface (PoE Supported)
ALARM IN	A1	AI	Alarm Input
	A2	GND	Grounding
ALARM OUT	B1	COM	Grounding Signal
	B2	NO	Door Lock Relay Output (Connect Electric Strike)

Name	No.	Interface	Description
	B3	NC	Door Lock Relay Output (Connect Electric Bolt or Magnetic Lock)

## 3.2 Wiring Description

### 3.2.1 Door Lock Wiring

Terminal NC/COM is set as default for connecting magnetic lock/electric bolt; terminal NO/ COM is set as default for connecting electric strike.

To connect electric lock, it is required to set the output of terminal NC/ COM/ NO to be electric lock via Batch Configuration Tool or iVMS-4200 client software or the web browser.

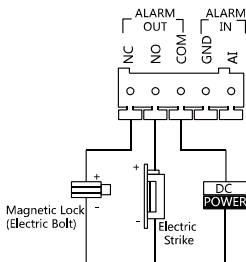

Figure 3-2 Door Lock Wiring

### 3.2.2 Door Magnetic Wiring

To connect door magnetic, it is required to set the output of terminal AI to be door status via Batch Configuration Tool or iVMS-4200 client software or the web browser.

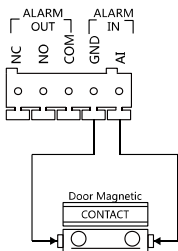

Figure 3-3 Door Magnetic Wiring

### 3.2.3 Exit Button Wiring

To connect exit button, it is required to set the output of terminal AI to be door status via Batch Configuration Tool or iVMS-4200 client software or the web browser.



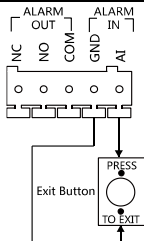

Figure 3-4 Exit Button Wiring

### 3.2.4 Alarm Device Input Wiring

When you set the output of terminal AI to be custom via Batch Configuration Tool or iVMS-4200 client software or the web browser, you can connect any alarm input device to the door station via the terminal AI.

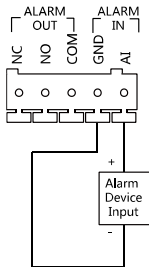

Figure 3-5 Alarm Device Input Wiring

## 4 Installation

### *Before you start:*

- Make sure the device in the package is in good condition and all the assembly parts are included.
- The device supports two ways of power supply: 12 VDC, or PoE power supply. Please make sure your power supply matches your door station.
- Make sure all the related equipment is power-off during the installation.
- Make sure the wall is strong enough to withstand 4 times the weight of the door station.
- Check the specification of the product for the installation environment.

### 4.1.1 Wall Mounting Plate

To install the door station onto the wall, you are required to use a matched mounting plate.

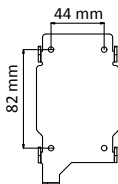

Figure 4-1 Wall Mounting Plate

## 4.1.2 Wall Mounting

### Steps:

1. Fix the wall mounting plate to the wall with 4 expansion screws.

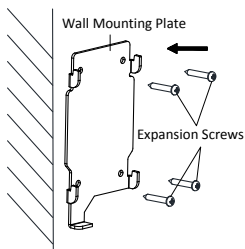

Figure 4-2 Install the Plate

2. Insert terminal blocks into the interfaces of the door station body, and connect the network cable.

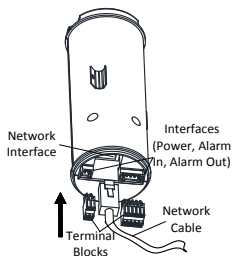

Figure 4-3 Insert Terminals and Network Cable

3. Fix the door station body to the protective shield tightly.

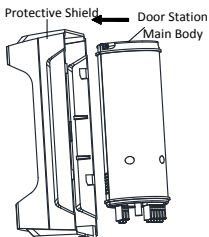

Figure 4-4 Fix the Body to the Shield

4. Hook the door station to the wall mounting plate tightly.

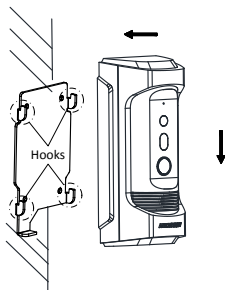

Figure 4-5 Hook the Door Station to the Plate

5. Use the set screw to secure the door station with the mounting plate.

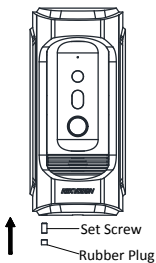

Figure 4-6 Secure the Door Station

## 5 Remote Operation

### 5.1 Activating Device

#### *Purpose:*

You are required to activate the device first by setting a strong password for it before you can use the device.

Activation via Batch Configuration Tool, Activation via Web Browser, and activation via iVMS-4200 client software are supported. Here take activation via Batch Configuration Tool and Activation via Web Browser as example to introduce the device activation. Please refer to the user manual for the activation via iVMS-4200 client software.

#### 5.1.1 Activation via Web Browser

#### *Steps:*

1. Power on the device, and connect the device to the network.
2. Input the default IP address to the address bar of the web browser, and click **Enter** to the activation interface.

Activate

User Name admin

Password

The valid password (8 to 16 characters) should contain two or more of the following character types: numeric, lowercase, uppercase, and special character.

Confirm Password

OK

Figure 5-1 Activation Interface (Web)

## 3. Create a password, and confirm the password.



**STRONG PASSWORD RECOMMENDED**– We highly recommend you create to a strong password of your own choosing (using a minimum of 8 characters, including upper case letters, lower case letters, numbers, and special characters) in order to increase the security of your product. And we recommend you to reset your password regularly, especially in the high security system, resetting the password monthly or weekly can better protect your product.

4. Click **OK** to activate the device.

The device default IP address is 192.0.0.65.

## 5.1.2 Activation via Batch Configuration Tool

### Steps:

## 1. Run the Batch Configuration Tool.

Index	Device Type	IP Address	Port	Software Version	Serial No.	Security Status	Added
1	XX-XXXX-XX	10.16.2.77	8000	Vxxxx build xxxxxx	XX-XXXXXX-XXXXXXXXXXXXXXXXXXXXXXXXXXXX	Activated	Yes
2	XX-XXXXXX-XX	10.16.2.103	8000	Vxxxx build xxxxxx	XX-XXXXXX-XXXXXXXXXXXXXXXXXXXXXXXXXXXX	Activated	No
3	XX-XXXX-XX	10.16.2.114	8000	Vxxxx build xxxxxx	XX-XXXXXX-XXXXXXXXXXXXXXXXXXXXXXXXXXXX	Activated	No
4	XX-XXXX-XX	10.16.2.222	8000	Vxxxx build xxxxxx	XX-XXXXXX-XXXXXXXXXXXXXXXXXXXXXXXXXXXX	Activated	No
5	XX-XXXX-XX	192.0.0.65	8000	Vxxxx build xxxxxx	XX-XXXXXX-XXXXXXXXXXXXXXXXXXXXXXXXXXXX	Inactive	No

Figure 5-2 Select Inactive Device

2. Select an inactivated device and click **Activate**.



**Activate**

Password:

Valid password range [8-16].  
You can use a combination  
of numbers, lowercase,  
uppercase and special  
character for your password  
with at least two kinds of  
them contained.

Confirm Password:

**OK** Cancel

Figure 5-3 Activation Interface (Batch Configuration Tool)

3. Create a password, and confirm the password.



**STRONG PASSWORD RECOMMENDED**— *We highly recommend you create to a strong password of your own choosing (using a minimum of 8 characters, including upper case letters, lower case letters, numbers, and special characters) in order to increase the security of your product. And we recommend you to reset your password regularly, especially in the high security system, resetting the password monthly or weekly can better protect your product.*

4. Click **OK** to activate the device.



- When the device is not activated, the basic operation and remote operation of device cannot be performed.
- You can hold the **Ctrl** or **Shift** key to select multiple devices in the online devices, and click **Activate** to activate devices in batch.



## 5.2 Editing Network Parameters

### Purpose:

To operate and configure the device via LAN (Local Area Network), you need connect the device in the same subnet with you PC. You can edit network parameters via batch configuration tool, iVMS-4200 software, and web browser. Here take editing network parameters via batch configuration tool as example.

### Steps:

1. Select an online activated device and click **Edit NET Parameters**.

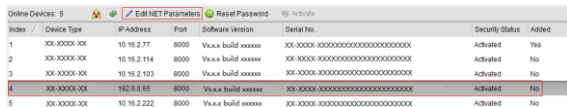

Index	Device Type	IP Address	Port	Software Version	Serial No.	Security Status	Added
1	XX-XXXX-XX	10.16.2.77	8000	V10.0x build xxxxxx	XX-XXXX-XXXXXXXXXXXXXXXXXXXX	Activated	Yes
2	XX-XXXX-XX	10.16.2.114	8000	V10.0x build xxxxxx	XX-XXXX-XXXXXXXXXXXXXXXXXXXX	Activated	No
3	XX-XXXX-XX	10.16.2.103	8000	V10.0x build xxxxxx	XX-XXXX-XXXXXXXXXXXXXXXXXXXX	Activated	No
4	XX-XXXX-XX	192.0.0.65	8000	V10.0x build xxxxxx	XX-XXXX-XXXXXXXXXXXXXXXXXXXX	Activated	No
5	XX-XXXX-XX	10.16.2.222	8000	V10.0x build xxxxxx	XX-XXXX-XXXXXXXXXXXXXXXXXXXX	Activated	No

Figure 5-4 Click Edit NET Parameters Button

2. Change the device IP address and gateway address to the same subnet with your PC. Or enable **DHCP** to get the IP address automatically.
3. Input the password and click **OK** to activate the network parameters modification.

Edit NET Parameters	
IP Address:	10.16.6.163
Subnet Mask:	255.255.255.0
Gateway Address:	10.16.6.254
Port No.:	8000
Password:	
<input type="checkbox"/> Enable DHCP	
<input type="button" value="OK"/> <input type="button" value="Cancel"/>	

Figure 5-5 Edit Network Parameters



- The default port No. is 8000.
- After editing the network parameters of device, you should add the devices to the device list again.

## 5.3 Adding Device

To configure the activated device via batch configuration tool and iVMS-4200 client software remotely, you should add the device to the tool or the software first.

3 ways for adding the device are supported: adding active online device within your subnet, adding device by IP address, and adding device by IP segment. Here take adding online device and adding device by IP address via batch configuration tool as example.

### 5.3.1 Adding Online Device

*Before you start:*

Make sure the device to be added is in the same subnet with your PC. Otherwise, please edit network parameters first.

### Steps:

1. Select an active online device or hold the **Ctrl** or **Shift** key to select multiple devices in the online devices list.

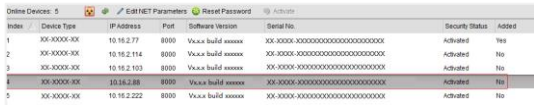

Index	Device Type	IP Address	Port	Software Version	Serial No.	Security Status	Added
1	XX-XXXX-XX	10.16.2.77	8000	Valka build 888888	XX-XXXX-XXXXXXXXXXXXXXXXXXXXXX	Activated	Yes
2	XX-XXXX-XX	10.16.2.114	8000	Valka build 888888	XX-XXXX-XXXXXXXXXXXXXXXXXXXXXX	Activated	No
3	XX-XXXX-XX	10.16.2.103	8000	Valka build 888888	XX-XXXX-XXXXXXXXXXXXXXXXXXXXXX	Activated	No
4	XX-XXXX-XX	10.16.2.88	8000	Valka build 888888	XX-XXXX-XXXXXXXXXXXXXXXXXXXXXX	Activated	No
5	XX-XXXX-XX	10.16.2.222	8000	Valka build 888888	XX-XXXX-XXXXXXXXXXXXXXXXXXXXXX	Activated	No

Figure 5-6 Online Devices Interface

2. Click the  button to pop up the login dialog box.

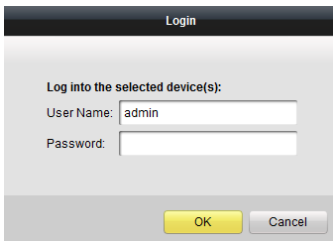

Login

Log into the selected device(s):

User Name:

Password:

Figure 5-7 Login Dialog Box

3. Input the user name and password.
4. Click **OK** to save the settings.



- Only devices successfully logged in will be added to the device list for configuration.

- If you add devices in batch, please make sure selected devices have the same user name and password.

### 5.3.2 Adding Device by IP Address

#### Steps:

1. Click the  button to pop up the adding devices dialog box.



Figure 5-8 Adding Button

2. Select IP Address in the adding mode drop-down list.
3. Input the IP address, and set the port No., user name and password of the device.

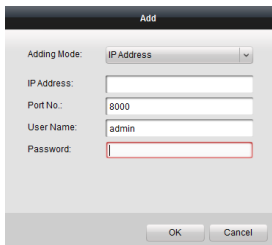

The screenshot shows a dialog box titled "Add". It contains the following fields and controls:

- Adding Mode: IP Address (dropdown menu)
- IP Address: [text input field]
- Port No.: 8000 (text input field)
- User Name: admin (text input field)
- Password: [text input field]
- Buttons: OK, Cancel

Figure 5-9 Adding by IP Address

4. Click **OK** to add the device to the device list.



- You cannot add the device(s) to the device list if the user name and password are not identical.

- When you add devices by IP Address, or IP Segment, the devices should be online devices.

## 5.4 Accessing via Web Browser

### **System Requirement:**

Operating System: Microsoft Windows XP SP1 and above version

CPU: 2.0 GHz or higher

RAM: 1G or higher

Display: 1024×768 resolution or higher

Web Browser: Internet Explorer 8.0 to 11

### **Steps:**

1. Open the web browser.
2. Input the device IP address in the address bar, and press **Enter** key to enter the login interface.



Figure 5-10 Login Interface

3. Input the user name and password.
4. Click **Login**.

5. Install the plug-in before viewing the live view and configuring the device. Please follow the installation prompts to install the plug-in.

[Please click here to download and install the plug-in. Close the browser when installing the plug-in.](#)

Figure 5-11 Downloading Plug-in

6. Reopen the web browser after the installation of the plug-in, and repeat steps 2 to 4 to login.



- The default IP address of the device is 192.0.0.65.
- If the device is not activated, please activate the device first (5.1 *Activating Device*).
- The device IP address gets locked if the admin user performs 7 failed password attempts.

## 6 Local Operation

### *Before you start:*

- Make sure the door station has been activated.
- Make sure the network cable is well-connected.

### *Purpose:*

You can call the resident (the indoor station) or the center (the master station) via the door station by pressing or holding the call button.

Default settings of the call button: when you press the call button, it calls the resident, and when you hold the call button, it calls the center.

### *Steps:*

1. Press the call button to call the resident.
2. The resident can accept/decline the calling from the door station, and unlock the door via the indoor station.

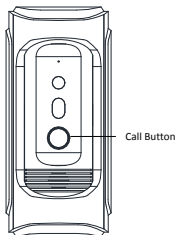

Figure 6-1 Call Button



- Besides the indoor station, you can also unlock the door by the master station, the client software, and the web.
- When the video intercom between you and the resident is realized, you can speak to the resident, and the live view of door station will be displayed on the connected indoor station.
- When live view of door station is displayed on other devices or door station is calling resident, the door station will detect the brightness of video. When the brightness is lower than the expected threshold, the supplement light will be enabled.
- When the supplement light is enabled, the backlight of key will be auto-enabled, otherwise, the door station will detect the brightness of live view and enable the backlight of key when the brightness of live view is lower than expected threshold.



## 7 Appendix

### Installation Notice

While installing the door station, make sure that the distance between any two devices is far enough to avoid the howling and echo. The distance between two devices is recommended to be longer than 10 meters.



Devices mentioned here refer to indoor station, outdoor station and master station.

### Wiring Cables

Cable	Specification
Power Cord of Door Station	RVV 2*1.0
Network Cable of Door Station	UTP-five Categories
Door Lock Wiring (With Door Magnetic)	RVV 4*1.0
Door Lock Wiring (Without Door Magnetic)	RVV 2*1.0
Exit Button Wiring	RVV 2*0.5



First Choice for Security Professionals