



HIKVISION

19/22/24-inch LCD Display Unit

User Manual

PN:G6AUM18500001

Thank you for purchasing our product. If there is any question or request, please do not hesitate to contact us. This manual may contain several technically incorrect places or printing errors, and the content is subject to change without notice. The updates will be added into the new version of this manual. We will readily improve or update the products or described in the manual.

This manual, as well as the software described in it, is furnished under license and may be used or copied only in accordance with the terms of such license. The content of this manual is furnished for informational use only, is subject to change without notice, and should not be construed as a commitment by Hikvision Digital Technology Co., Ltd. (Hikvision). Hikvision assumes no responsibility or liability for any errors or inaccuracies that may appear in the book.

Except as permitted by such license, no part of this publication may be reproduced, stored in a retrieval system, or transmitted, in any form or by any means, electronic, mechanical, recording, or otherwise, without the prior written permission of Hikvision.

HIKVISION MAKES NO WARRANTIES, EXPRESS OR IMPLIED, INCLUDING WITHOUT LIMITATION THE IMPLIED WARRANTIES OF MERCHANTABILITY AND FITNESS FOR A PARTICULAR PURPOSE, REGARDING THE HIKVISION SOFTWARE. HIKVISION DOES NOT WARRANT, GUARANTEE, OR MAKE ANY REPRESENTATIONS REGARDING THE USE OR THE RESULTS OF THE USE OF THE HIKVISION SOFTWARE IN TERMS OF ITS CORRECTNESS, ACCURACY, RELIABILITY, CURRENTNESS, OR OTHERWISE. THE ENTIRE RISK AS TO THE RESULTS AND PERFORMANCE OF THE HIKVISION SOFTWARE IS ASSUMED BY YOU. THE EXCLUSION OF IMPLIED WARRANTIES IS NOT PERMITTED BY SOME STATES. THE ABOVE EXCLUSION MAY NOT APPLY TO YOU.

IN NO EVENT WILL HIKVISION, ITS DIRECTORS, OFFICERS, EMPLOYEES, OR AGENTS BE LIABLE TO YOU FOR ANY CONSEQUENTIAL, INCIDENTAL, OR INDIRECT DAMAGES (INCLUDING DAMAGES FOR LOSS OF BUSINESS PROFITS, BUSINESS INTERRUPTION, LOSS OF BUSINESS INFORMATION, AND THE LIKE) ARISING OUT OF THE USE OR INABILITY TO USE THE HIKVISION SOFTWARE EVEN IF HIKVISION HAS BEEN ADVISED OF THE POSSIBILITY OF SUCH DAMAGES. BECAUSE SOME STATES DO NOT ALLOW THE EXCLUSION OR LIMITATION OF LIABILITY FOR CONSEQUENTIAL OR INCIDENTAL DAMAGES, THE ABOVE LIMITATIONS MAY NOT APPLY TO YOU.

Regulatory Information



2002/96/EC (WEEE directive): Products marked with this symbol cannot be disposed of as unsorted municipal waste in the European Union. For proper recycling, return this product to your local supplier upon the purchase of equivalent new equipment, or dispose of it at designated collection points. For

more information see: www.recyclethis.info.



2006/66/EC (battery directive): This product contains a battery that cannot be disposed of as unsorted municipal waste in the European Union. See the product documentation for specific battery information. The battery is marked with this symbol, which may include lettering to indicate cadmium (Cd), lead (Pb), or mercury (Hg). For proper recycling, return the battery to your supplier or to a designated collection point. For more information see: www.recyclethis.info.

Chapter1. Introduction

1.1 Key Features

- DS-D5019 Series:Support 1366×768 HD display;
- DS-D5022/5024 Series:Supports 1920×1080 FHD display;
- User-friendly operation menu;
- Three image modes to adapt different environment;
- 1 channel HDMI 1.3 input interface;
- Support software spread-spectrum technology to reduce EMI radiation;
- Standby Power Consumption is lower than 0.5W;
- DS-D5019:Viewing Angle:Horizontal 90°, Vertical 65° ;
- DS-D5022/24:Viewing Angle:Horizontal 170°, Vertical 160° ;
- 2Wx2 Speakers efficient output;

1.2 Power Supply Connection

Insert the 3-pin power device into well-grounded socket and turn the rocker switch on.

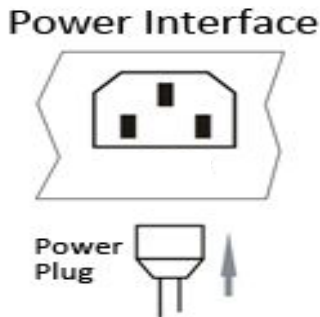

Figure 1.1 Power Input

- Power input specification from 100VAC to 240VAC or provide automatic switching between high line and low line input ranges.
- Turn off the main power switch of the display unit, and pull the plug from the power outlet if the display unit will not be used for a long time.
- Never connect the device to a DC power.

Chapter2. Device Interfaces

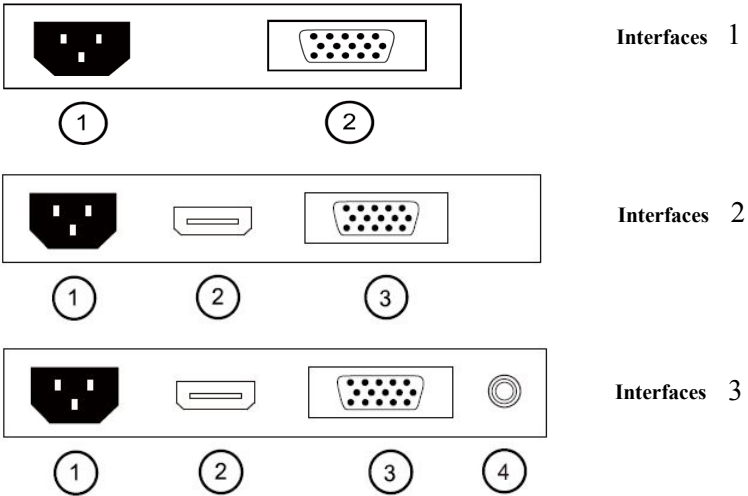

Figure 2.1 Rear Panel of Device

Interfaces	Interfaces 1	Interfaces 2	Interfaces 3
POWER IN	Power Input	Power Input	Power Input
VGA IN	VGA Analog Signal Input	VGA Analog Signal Input	VGA Analog Signal Input
HDMI IN		HDMI Digital Signal Input	HDMI Digital Signal Input
AUDIO IN			Audio Input

Chapter3. Panel Keys

Keys on lower right corner of the display unit panel are shown in the Figure 3.1 Keys on the Display Unit.



Figure 3.1 Keys on the Display Unit

The functions of the keys on lower right corner of the display unit vary according to different situations.

Chapter4. Basic Operation

4.1 Input Source Selection(optional)

Turn on the display unit when the power supply is on and input source is confirmed.

Press ◀ key of the remote controller to enter the menu as shown on the right. DS-D5019/22 /24inch LCD display unit includes 2 input sources as HDMI and VGA signal. Press direction keys to select the input source and press MENU to accomplish the input source selection.



Figure 4.1 Input Source

4.1 Contrast

Press ◀ key of the remote controller to enter the menu as shown on the right. press ◀ or ▶ to adjust the value of contrast. Press MENU to accomplish the contrast adjustment.



Figure 4.1 Input Source

4.2 Input Audio Volume Adjustment(optional)

Turn on the display unit when the power supply is on and input source is confirmed.

Press ▶ key of the remote controller to enter the menu as shown on the right. press ◀ or ▶ to adjust the value of volume. press MENU to accomplish the volume adjustment.



Figure 4.2 Audio Volume

4.2 Brightness

Press ▶ key of the remote controller to enter the menu as shown on the right. press ◀ or ▶ to adjust the value of Brightness. press MENU to accomplish the Brightness adjustment.

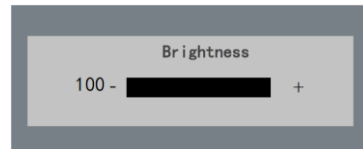

Figure 4.2 Brightness

4.3 Auto Adjust

Turn on the display unit when the power supply is on and input source is confirmed.

Press AUTO key of the remote controller to enter the menu as shown on the right(In VGA Signal).

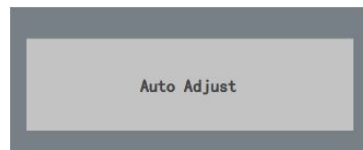

Figure 4.3 Input Source

4.4 Main Menu

4.4.1 Image Settings

Purpose:

You can adjust the picture parameters by switching image modes and adjust the values of contrast, brightness, color temperature, auto adjust, color adjust.

Steps:

1. Press **MENU** key to enter the main menu interface as shown below.
2. Press **MENU** key to enter the setting you want.
3. Press ◀ or ▶ to adjust the value. It applies for adjusting contrast, brightness, color temp and other parameters.



- Contrast, Brightness: Press ◀ or ▶ to set the contrast, the range varies from 0-100.
- Color temperature :Press ◀ or ▶ to set the color temperature you need.
- Gray indicates that under current mode or current input source condition it is not adjustable; Yellow indicates that it is adjustable.

4. Press **AUTO** key to return to the main menu after accomplishing the adjustment.

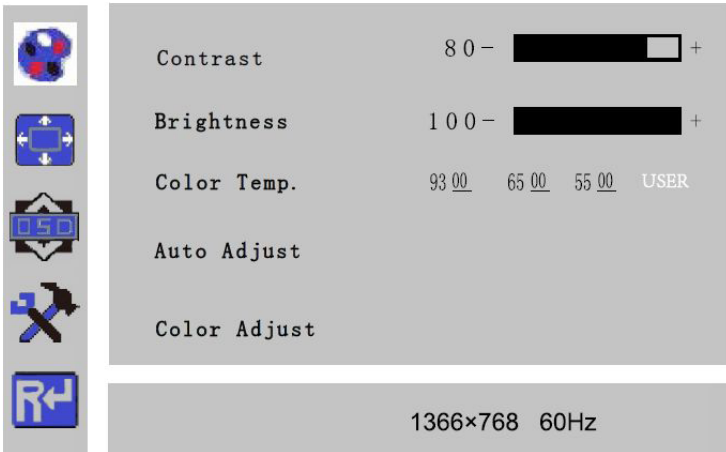

Figure 4.4.1 Image Settings

4.4.2 Image Adjustment

Purpose:

When the input source is selected VGA, you can adjust the VGA parameters. It is for adjusting VGA H position, V Position, clock and phase.

Steps:

1. Press **Menu** key to enter the main menu interface.
2. Press **◀** key to enter the VGA parameter setting interface. (You can select **Auto Adjust** and press **◀** or **▶** to adjust the VGA parameters automatically or adjust it manually)
3. Select **H Position** and press **◀** or **▶** to adjust the **H Position**
4. Select **V Position** and press **◀** or **▶** to adjust the **V position**.
5. Select **Clock** and press **◀** or **▶** to adjust the **clock**.
6. Select **Phase** and press **◀** or **▶** to adjust the **phase**.



The range of the adjustment varies between 0-100.

7. Press **MENU** key to return to the main menu after accomplishing the adjustment.

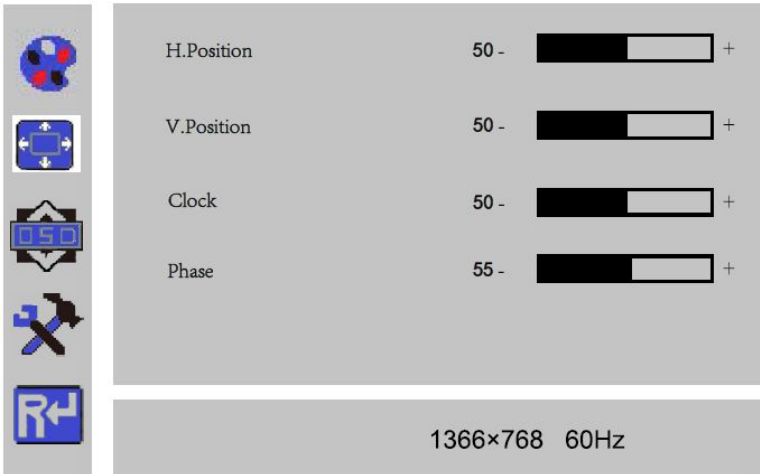

Figure 4.4.2 Image Adjustment

4.4.3 OSD Setting

Purpose:

You can set the language, blending and OSD duration of the menu.

Steps:

1. Press **MENU** key to enter the main menu interface.
2. Press **◀** key twice and press **MENU** key to enter the **【Language】** interface, press **◀** or **▶** to switch the language you want.
3. Select **OSD H.Pos/OSD V.Pos** to adjust the position of OSD with **◀** or **▶**.
4. Select **OSD Timer** to adjust the OSD duration with **◀** or **▶**: **5Sec~60Sec**.
5. Select **Transparency** to adjust the OSD transparency value with **◀** or **▶**.
6. Press **AUTO** key to return to the main menu after accomplishing the adjustment.

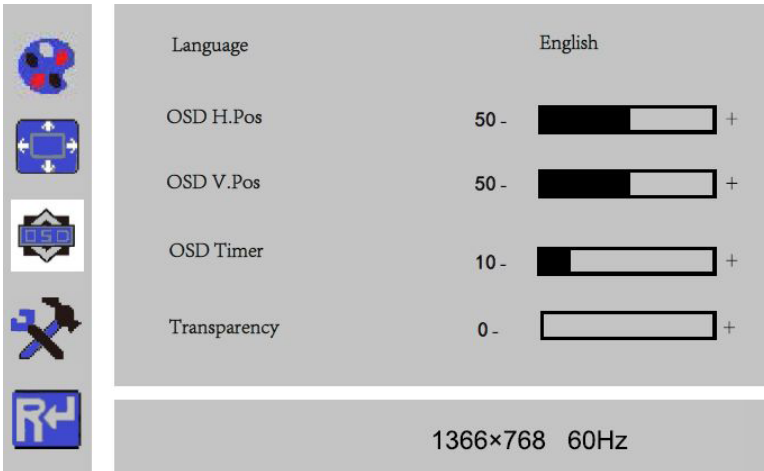

Figure 4.4.3 OSD Setting

4.4.4 Other Settings

Purpose:

You can set Mode, Audio Volume, Signal Source, Aspect Ratio, DCR.

Steps:

1. Press **MENU** key to enter the main menu interface.
2. Press triple ◀ key and press MENU key to enter the **Mode** interface, press ◀ or ▶ to switch the mode between **PC/GAME/MOVIE**.
3. Press ◀ or ▶ to adjust the **Audio Volume** from 0~100(optional).
4. Press ◀ or ▶ to change the **Signal Source** between **VGA** and **HDMI**(optional).
5. Press ◀ or ▶ to switch the **Aspect Ratio** between **16:9/AUTO/4:3**.
6. Press ◀ or ▶ to switch the **DCR On/Off**.
7. Press **MENU** key to return to the main menu after accomplishing the adjustment.

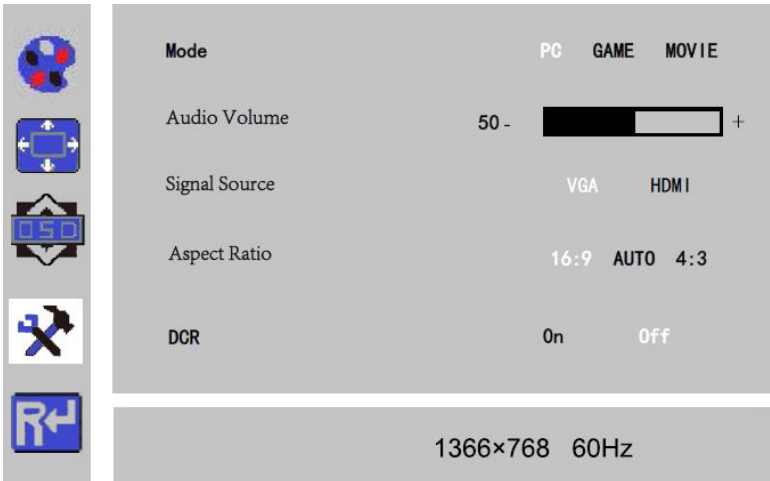

Figure4.4.4 Other Settings

4.4.5 Reset Setting

Purpose:

You can reset settings to the factory defaults.

Steps:

1. Press **MENU** key to enter the main menu interface.
2. Press **◀** key 4 times and press **MENU** key to reset settings to the factory defaults.

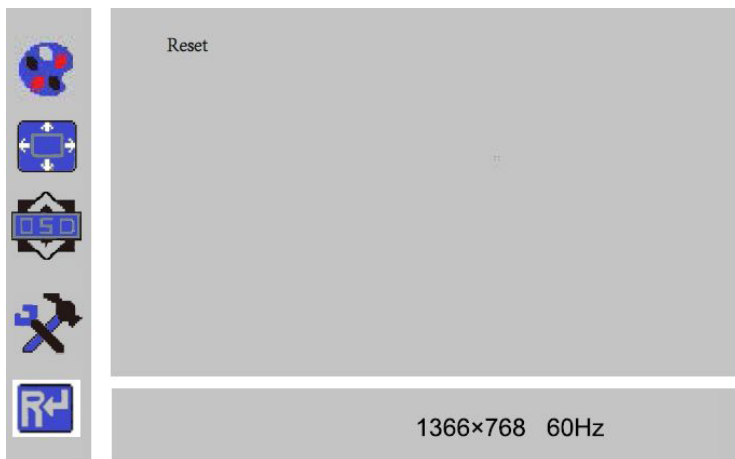
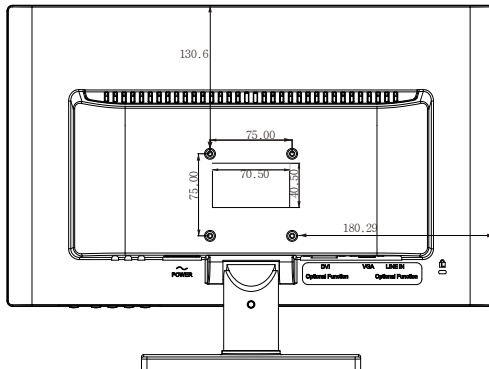
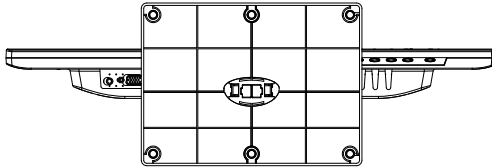
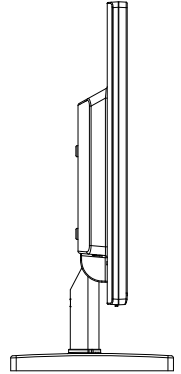
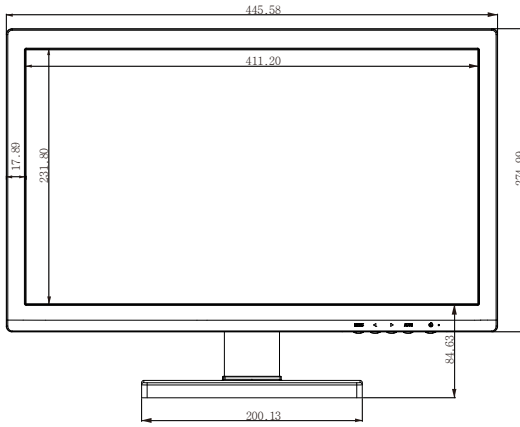
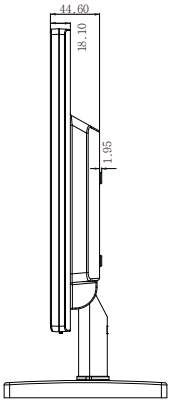
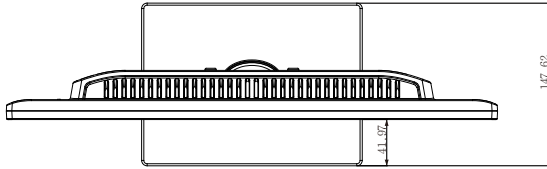

Figure 4.4.5 Reset Setting

Appendix: Specifications

Device Model	DS-D5019 Series			
Display Type	TFT-LED Backlight			
Screen Size	18.5"			
Color	16.7M			
Dot Pitch	0.300×0.300 mm			
Max Resolution	1366×768			
Best Operation Resolution	1366×768@60Hz			
Brightness	200cd/m ²			
Contrast	600:1			
Viewing Angle	Horizontal 90°, Vertical 65°			
Viewable Area	409.8×230.4mm			
		Interfaces 1	Interfaces 2	Interfaces 3
Interfaces	VGA Input Port	1	1	1
	AC Input Port	1	1	1
	HDMI Input Port	NA	1	1
	AUDIO Input Port	NA	NA	1
Power Supply	AC 100-240V; 50/60Hz			
Consumption	≤25W			
Standby Power Consumption	≤0.5W			
Operation Temperature	0°C~40°C (32°F~104°F)			
Operation Humidity	10%~85%			
Storage Temperature:	-20°C~55°C (-4°F~131°F)			
Storage Humidity:	5%~95%			
Bezel Material	Plastic			
Bezel Color	Black			
Wall-mounting Dot Site	75×75mm			
Wall-mounting Thread	M4			
Device Dimensions	446×335×148mm			
Package Dimensions	490×333×101mm			
G.W.	3.5Kg			
N.W.	2.8Kg			
Standard Package	Display Unit	1		
	VGA Cord	1		
	User Manual	1		
	Power Cord	1		
	Audio Cord (optional)	1		

Structure Figure



Appendix: Specifications

Device Model	DS-D5022 Series		
Display Type	TFT-LED Backlight		
Screen Size	21.5"		
Dot Pitch	0.248×0.248 mm		
Max Resolution	1920×1080		
Best Operation Resolution	1920×1080@60Hz		
Brightness	250cd/m ²		
Contrast	1000:1		
Color	16.7M		
Viewable Area	477×268mm		
Viewing Angle	Horizontal 170°, Vertical 160°		
		Interfaces 2	Interfaces 3
Interfaces2	VGA Input Port	1	1
	HDMI Input Port	1	1
	AC Input Port	1	1
	AUDIO Input Port	NA	1
Power Supply	AC 100-240V; 50/60Hz		
Consumption	≤30W		
Standby Power Consumption	≤0.5W		
Operation Temperature	0°C~40°C (32°F~104°F)		
Operation Humidity	10%~85%		
Storage Temperature:	-20°C~55°C (-4°F~131°F)		
Storage Humidity:	5%~95%		
Bezel Material	Plastic		
Bezel Color	Black		
Wall-mounting Dot Site	100×100mm		
Wall-mounting Thread	M4		
Device Dimensions	511×377×170mm		
Package Dimensions	561×426×103mm		
G.W.	4.5Kg		
N.W.	3.3Kg		
Standard Package	Display Unit		1
	VGA Cord		1
	User Manual		1
	Power Cord		1

Structure Figure

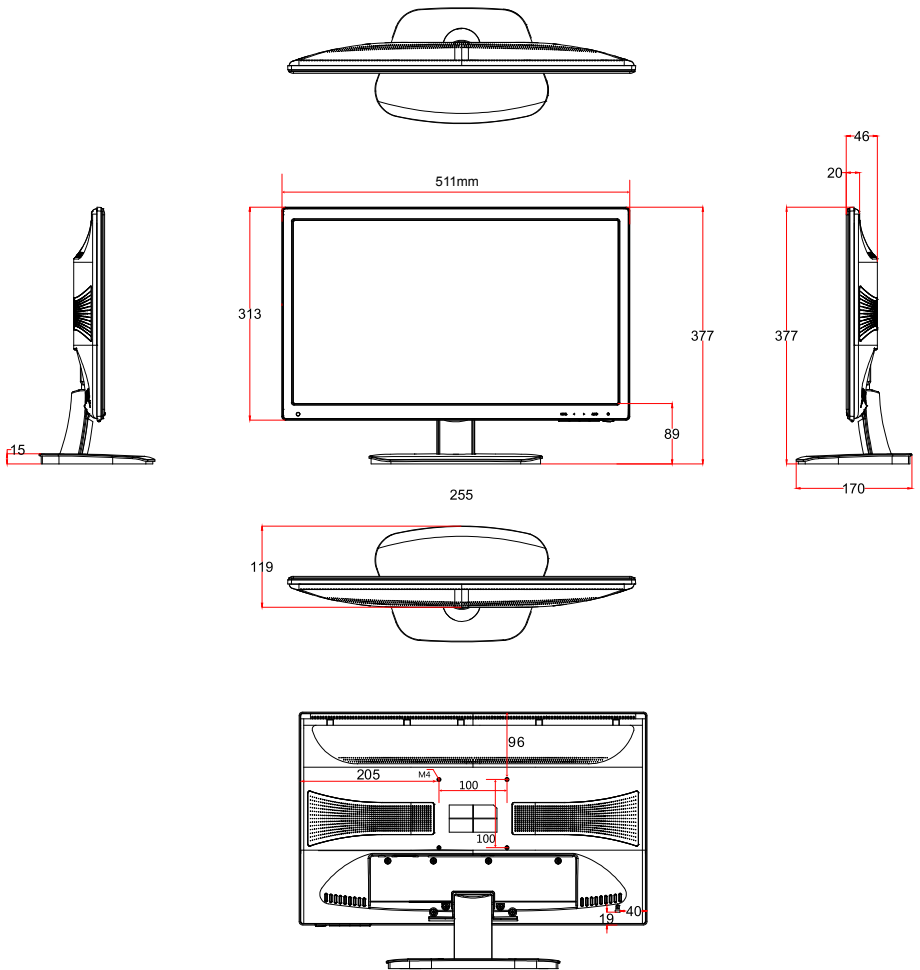

Appendix: Specifications

Device Model	DS-D5024 Series		
Display Type	TFT-LED Backlight		
Screen Size	23.6"		
Color	16.7M		
Dot Pitch	0.271×0.271mm		
Max Resolution	1920×1080		
Best Operation Resolution	1920×1080@60Hz		
Brightness	250cd/m ²		
Contrast	1000:1		
Viewing Angle	Horizontal 170°, Vertical 160°		
Viewable Area	521×293mm		
		Interfaces 2	Interfaces 3
Interfaces	VGA Input Port	1	1
	AC Input Port	1	1
	HDMI Input Port	1	1
	AUDIO Input Port	NA	1
Power Supply	AC 100-240V; 50/60Hz		
Consumption	≤30W		
Standby Power Consumption	≤0.5W		
Operation Temperature	0°C~40°C (32°F~104°F)		
Operation Humidity	10%~85%		
Storage Temperature:	-20°C~55°C (-4°F~131°F)		
Storage Humidity:	5%~95%		
Bezel Material	Plastic		
Bezel Color	Black		
Wall-mounting Dot Site	100×100mm		
Wall-mounting Thread	M4		
Device Dimensions	560×399×220mm		
Package Dimensions	614×465×109mm		
G.W.	5.4Kg		
N.W.	4.5Kg		
Standard Package	Display Unit	1	
	VGA Cord	1	
	User Manual	1	
	Power Cord	1	
	Audio Cord (optional)	1	

Structure Figure

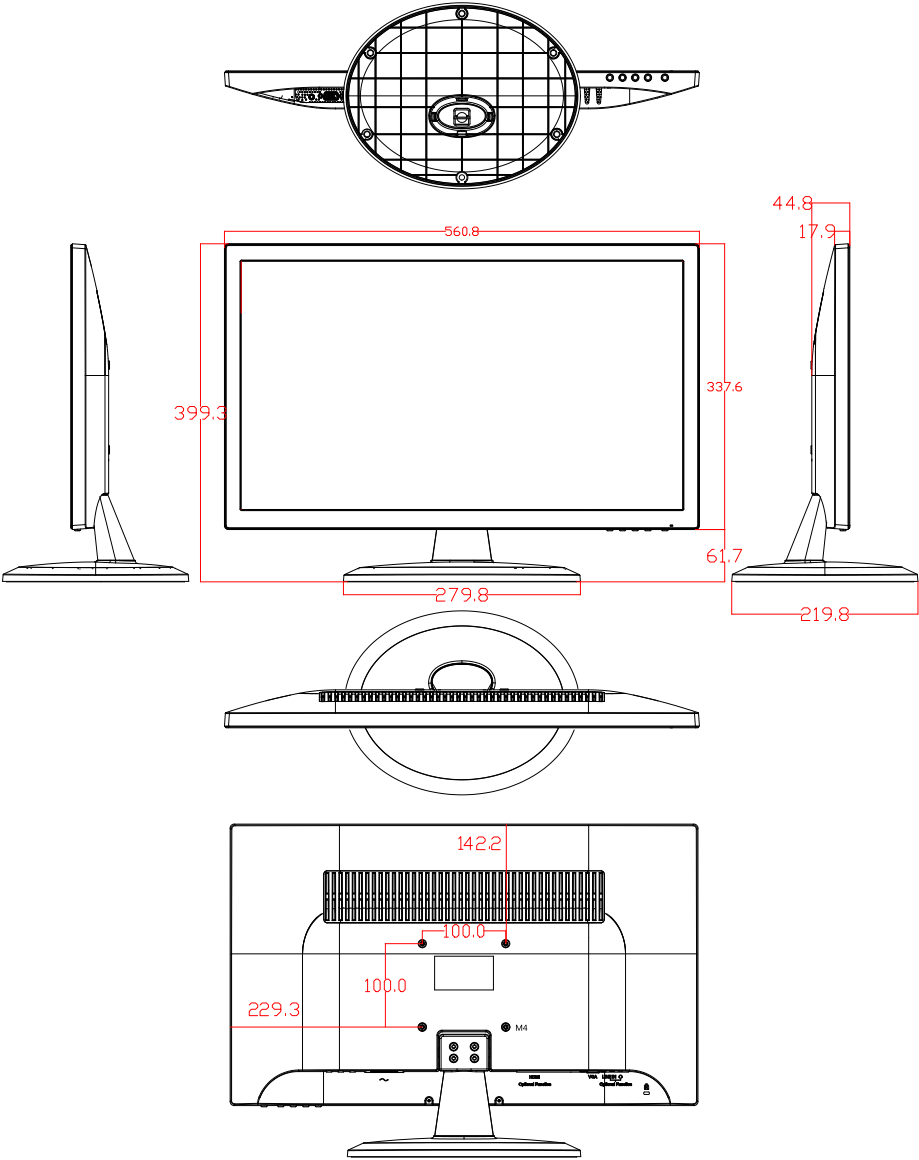



First Choice for Security Professionals